

PART NAME

NEMA 4X DIE CAST ALUMINUM ENCLOSURE

PART No.

AN-2864

AN-2864-B

REVISION DATE

3-19-14

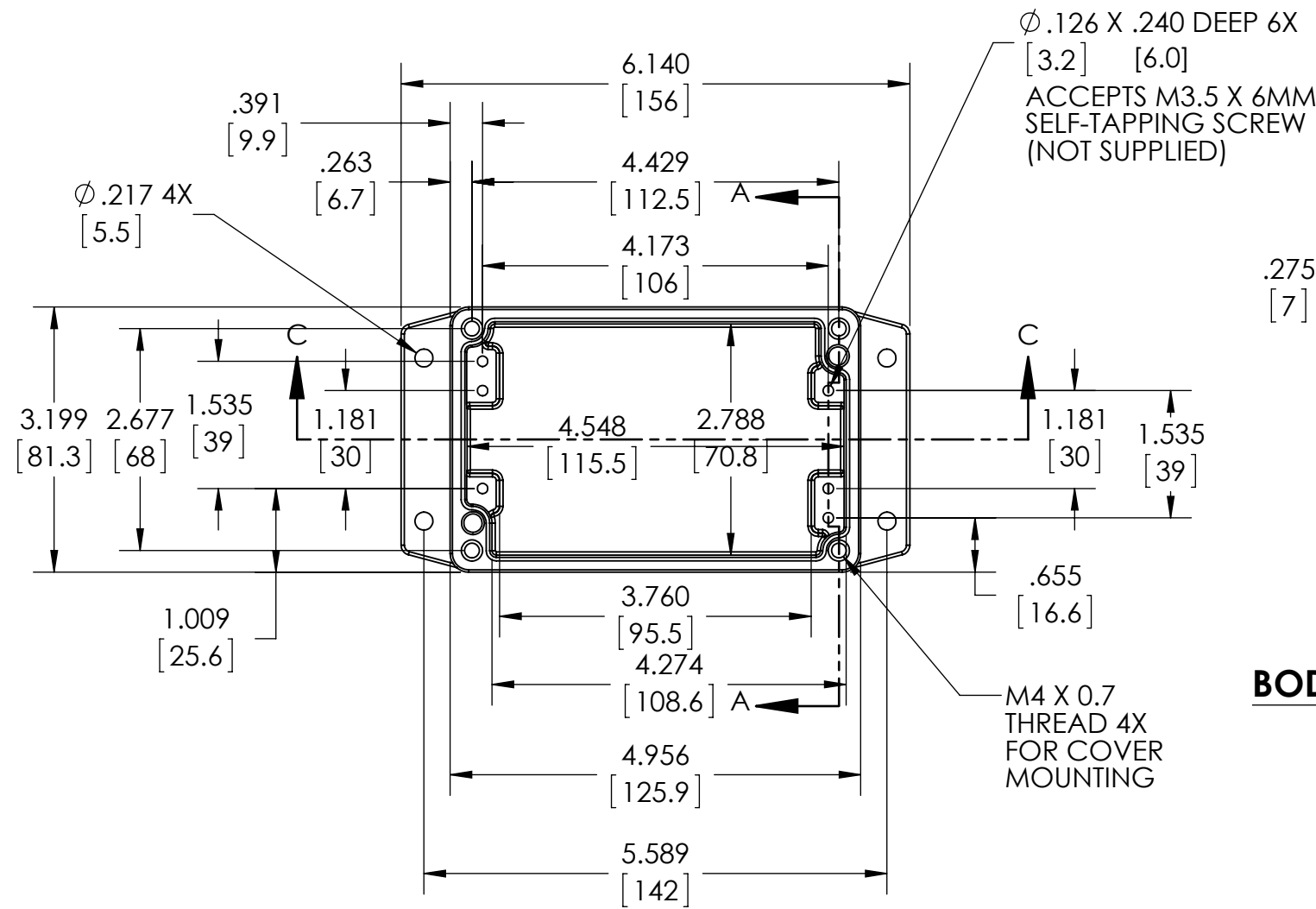

BODY

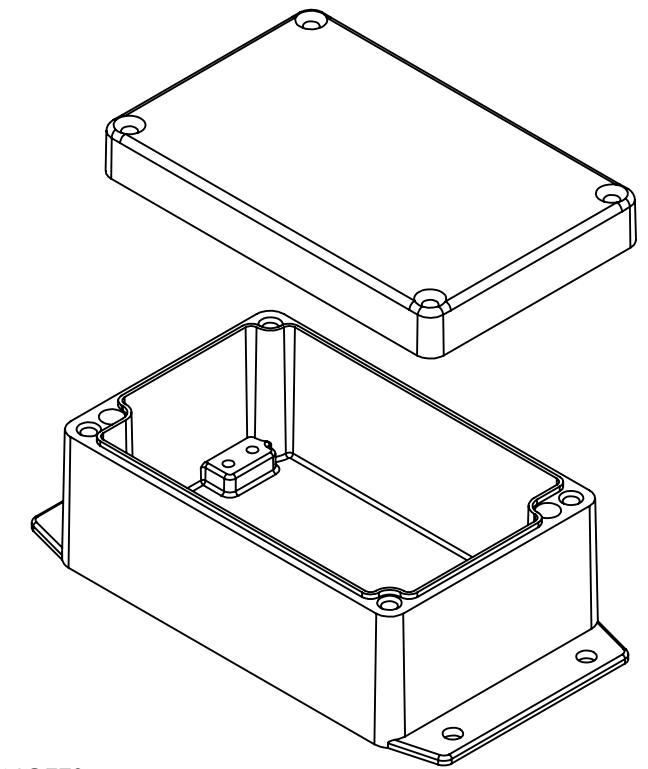
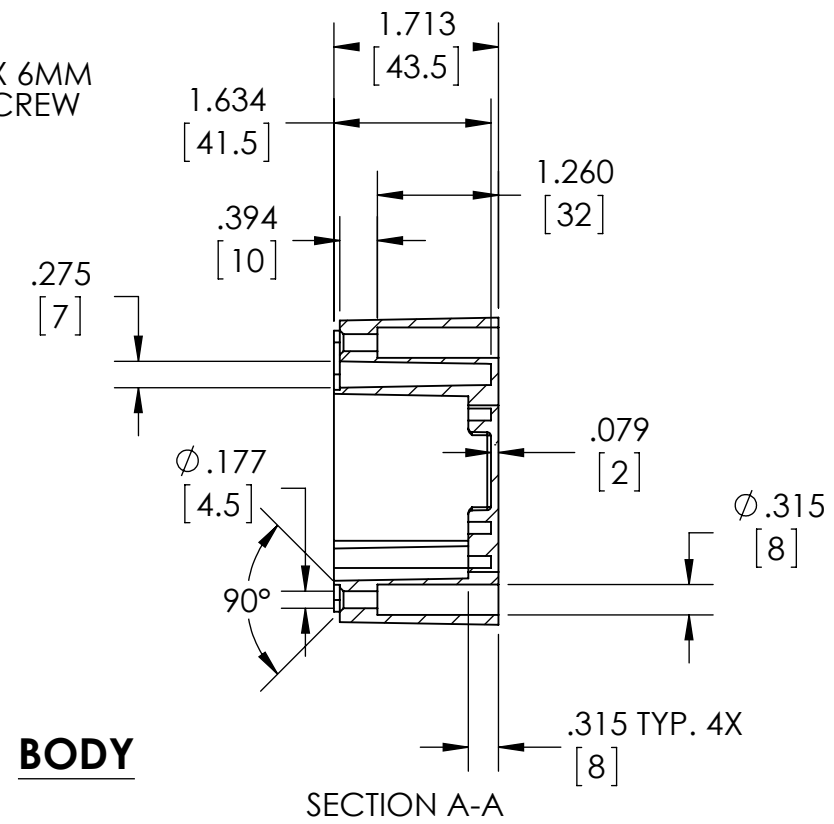

- NOTES:
- 1- MATERIAL: ALUMINUM ALLOY ADC-12
 - 2- FINISH: NATURAL (NO SUFFIX)
BLACK (SUFFIX -B)
 - 3- FOUR (4) M4 X 0.7mm SCREWS SUPPLIED FOR ASSEMBLY OF COVER TO BODY
 - 4- ALL HOLE DIAMETERS HAVE $\pm .005$ [.12] TOLERANCE. ALL OTHER DIMENSIONS HAVE $\pm .015$ [.38] TOLERANCE.
 - 5- ALL OUTSIDE DRAFT ANGLE: 1°
ALL INSIDE DRAFT ANGLE: 1/2°
 - 6- DIMENSIONS ARE INCH[MM]

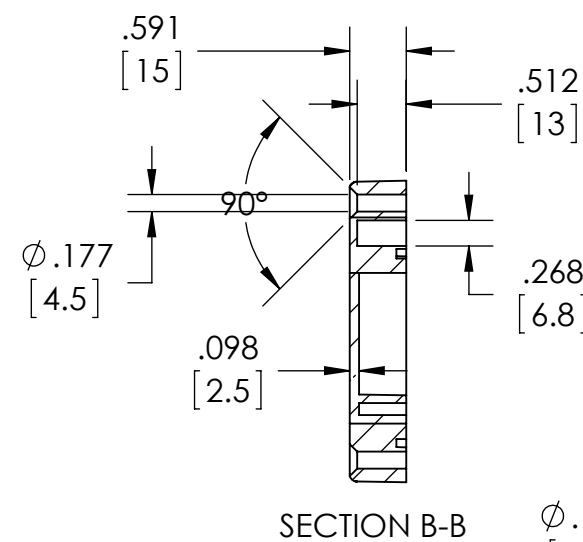
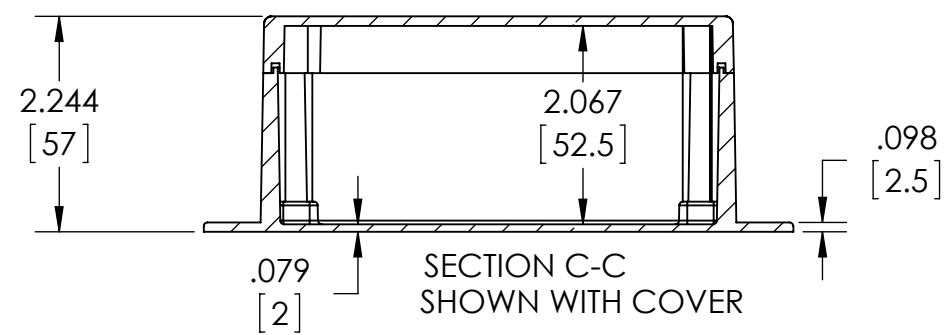

COVER

